

Varenummer: 2030100M24150A1U

Beskrivelse: E+G Justerfod
GN 30-100-M24-150-A1-U

Note: U Uden møtrik, sekskant i toppen, spændeflade i bunden

Mål

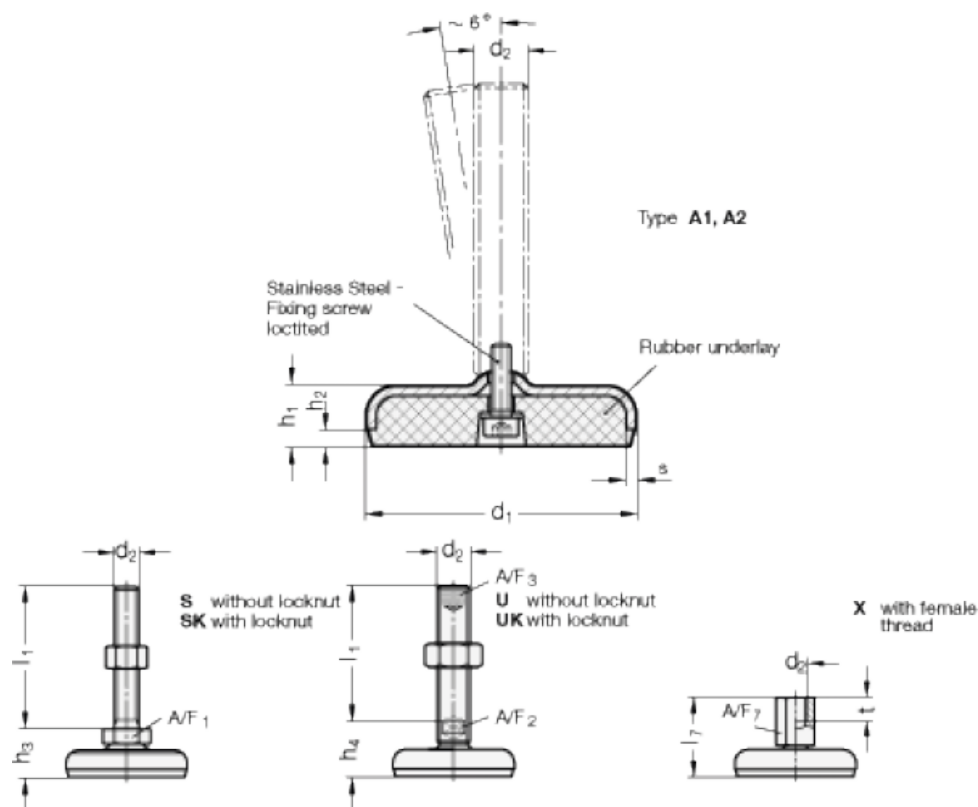

A/F2 = 19

s = 3

A/F3 = 12

d1 = 100

d2 = M24

h1 = 20

h2 = 6

h4 = 38

l1 = 150